

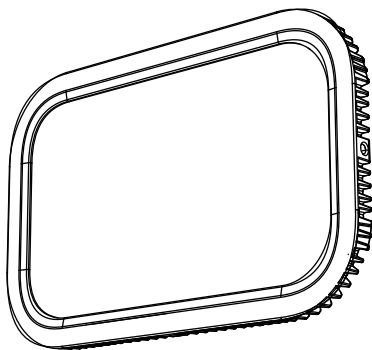

思锐E30B 双色温LED柔光灯



使用手册

前言

双色温LED柔灯E30B是超薄设计的多用途摄的长亮摄影灯，采用侧发光的设计，使得光线输出更均匀柔和，轻便和双供电模式设计，方便室内和外排使用，适用于静物拍摄、人物拍摄、视频拍摄、直播等场景。

主要特点

- (1) 轻巧便携，方便手持，自由布光。
- (2) LED双色温模式和12种情景特效模式自由调节。
- (3) 侧发光布置和多重柔光设计，照度高的同时光线柔和不刺眼。
- (4) 支持手机APP控制，可实现多灯联控。

包装清单

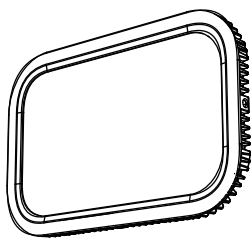

灯体* 1

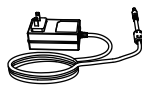

适配器 * 1

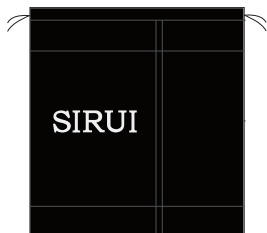

便携袋*1



保修卡*1



多功能手柄* 1

产品介绍

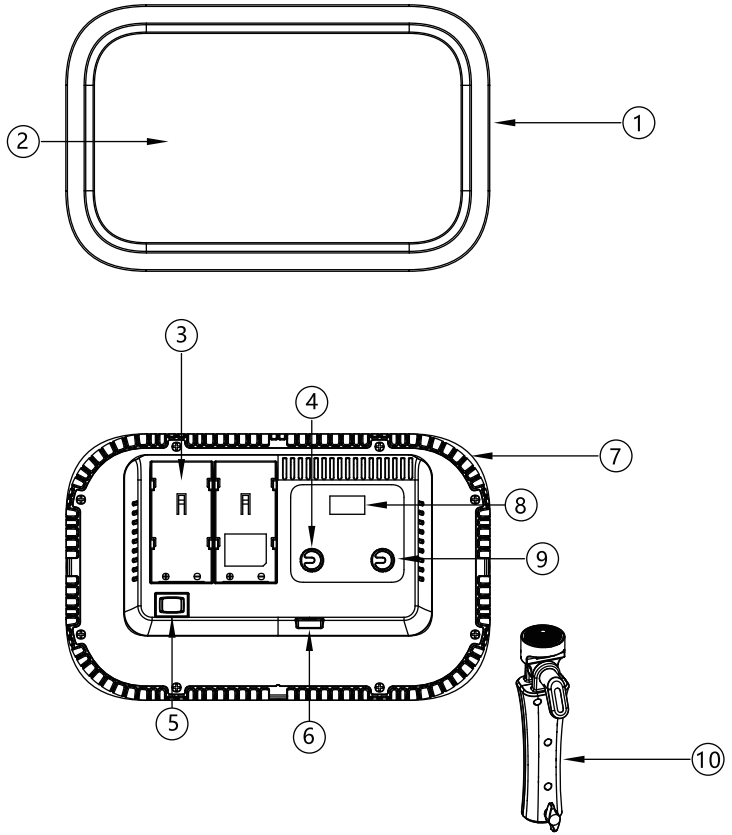

1	边框		6	DC电源插座
2	发光面		7	散热口
3	电池安装座		8	屏幕
4	SET旋钮		9	DIM旋钮
5	电源开关		10	多功能手柄

电源管理

1、适配器供电

输入100-240V,50/60Hz , 1.5A,输出：16.8V,3A

2、外置电池供电

安装座装2个NP-F970电池即可供电。（电池盒只供电池放电，不能充电，需两个电池同时使用）

操作说明

1、 开关机

使用电池供电时，开关往“ I ” 按下开机，往中间复位关机。

使用适配器供电时，开关往“ II ” 按下开机，往中间复位关机。

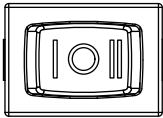

2、 模式选择：短按SET旋钮选择CCT模式/FX特效模式

2.1 CCT模式。



2.1.1色温调节：旋转SET旋钮调节色温，最小变量100K，调节范围2800-7000K。

2.1.2 亮度调节：旋转DIM旋钮，最小变量1%，调节范围0-100%。

2.2、情景特效模式

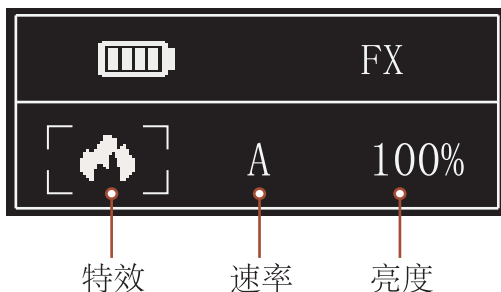

2.2.1 转动SET旋钮选择灯光特效，短按DIM选择A、B、C档位，转动DIM旋钮调整亮度。

2.2.2 亮度调节：旋转DIM旋钮，最小变量1%，调节范围0-100%。

2.2.3 情景特效模式有12类，用户可以根据需求选择：

序号	显示	场景	显示A	显示B	显示C
1	⚡	闪电	间歇	频繁	持续
2	💡	闪光灯	闪光	发布会	狗仔队
3	💡	故障灯	间歇	频繁	持续
4	📺	电视荧幕	慢速	中速	快速
5	🕯️	蜡烛	间歇	频繁	持续
6	🔥	火焰	柴火	篝火	火灾
7	🎆	烟花	短暂	连续	演出
8	💣	爆炸	间歇	频繁	持续
9	🔄	色温循环	慢速	中速	快速
10	📶	脉冲	慢速	中速	快速
11	🔥	电焊	间歇	频繁	持续
12	SOS	SOS	慢速	中速	快速

3、连接手机APP

3.1. 长按SET打开蓝牙（再次长按SET关闭蓝牙）

3.2. 扫描二维码下载“SIRUI Light”手机APP

3.3. 手机打开蓝牙，在“SIRUI Light”APP中连接对应的灯就可通过APP控制灯。

Q SIRUI Light



扫码下载App



具体操作请参考手机APP使用说明。

4、安装和固定

4.1 通过底部或者侧面1/4螺丝孔可以固定在带1/4螺丝柱的灯架或者桌面支架上使用。

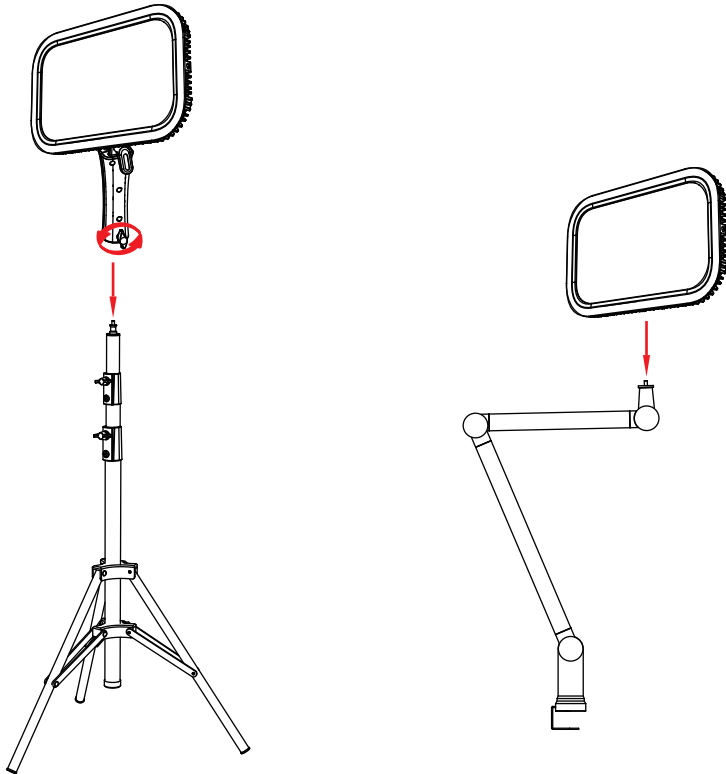

产品参数

型号	E30B
产品尺寸	269*169*36mm
产品重量	约880g
LED功率	约30W
色温范围	2800K~7000K
特效模式	12类
裸灯100%光照度	1m距离 800lux
TLCI	平均98
CRI	平均96
工作环境温度	-10°C-45°C
控制方式	手机APP
蓝牙无线控制距离	15m

设计和规格如有变更，恕不另行通知。

注意事项

- 1、请勿将灯放在高温高湿的地方。
- 2、请勿湿手接触产品，不可把产品浸入水中或暴露在雨中。
- 3、请使用配套适配器，其他规格有可能导致硬件损坏。如使用其他电源适配器造成的产品故障，不予保修。

维护保养

- 1、灯体在工作时，如发现异常，应立即关掉电源，查明原因。
- 2、灯体稍有发热为正常现象。
- 3、维修由本厂维修部负责。
- 4、本产品保修一年，消耗品适配器、电源线等不在一年保修范围内。
- 5、经发现，擅自检修此灯的，将取消一年保修期，维修需要收取相关费用。
- 6、如果本品出现故障或者被水淋湿，在专业人员维修后方可继续使用。
- 7、设计和规格如有变更，恕不另行通知。



SIRUI

SIRUI E30B Bi-Color Soft LED Panel

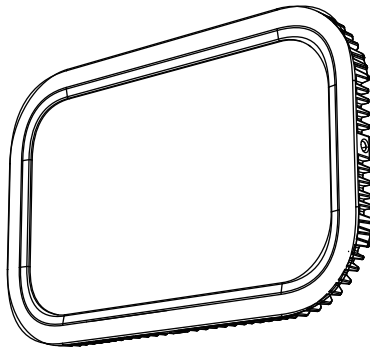

User Manual

Foreword

This Bi-color LED Light E30B is a slim multi-purpose continuous light. The use of side-view SMD LEDs makes the lights given out more soft and even. Featuring a compact body and supporting both battery and adapter power supplies, this light is suitable for various shooting scenarios, e.g. live, portrait shooting, video recording, etc.

Features

1. Compact and lightweight, easy to be held in hand.
2. Freely switch between the LED bi-color mode and the light effect mode.
3. The use of side-view SMD LEDs makes sure the lights given out are bright without being too harsh.
4. Support group control and APP control.

What's in the Box

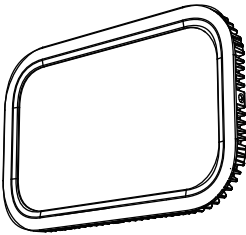

Light Body *1



Adapter *1

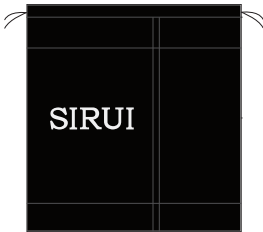

Pouch*1



Warranty Card*1



Handle*1

Names of Parts

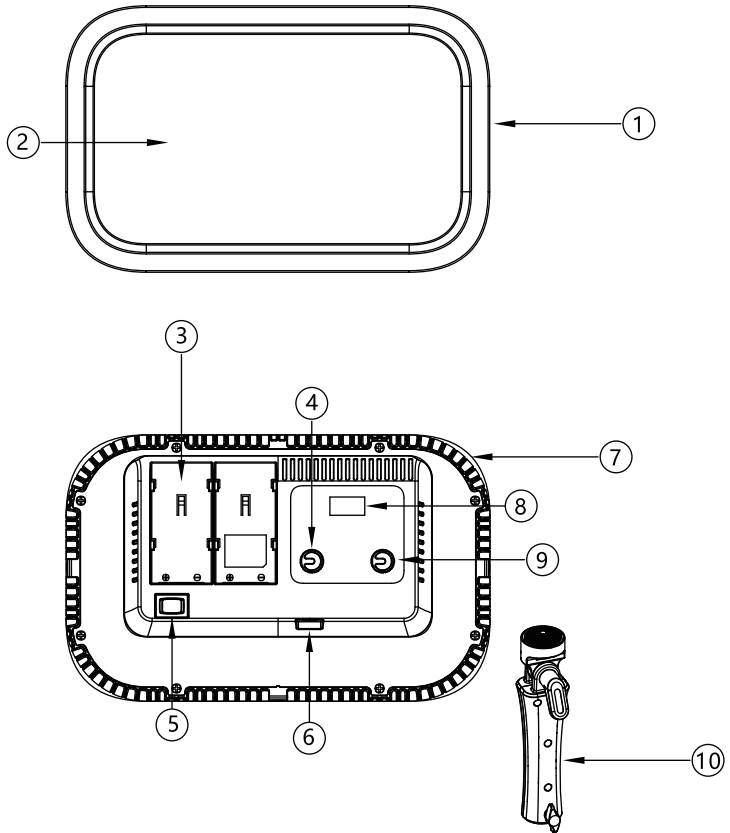

1	Frame		6	DC Power Socket
2	Light Board		7	Thermovent
3	Battery Compartment		8	Display
4	SET Dial		9	DIM Dial
5	Power Switch		10	Handle

1. Adapter Power Supply

Input: 100-240V~50/60Hz, 1.5A, output: 16.8V 3A

2. External Battery Power Supply

Install two NP-F970 batteries into the battery compartment. (The battery case is unable to charge the batteries. When powered by the battery, make sure there are at least two batteries in the case.)

Operation

1. Power On/Off

When powered by the battery, hit "I" to turn on the light, press the button in the middle to turn off the light.

When powered by the adapter, hit "II" to turn on the light, press the button in the middle to turn off the light.

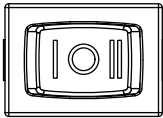

2. Mode Selection: Hit the SET dial to switch between the CCT mode and FX special effect mode.

2.1 CCT Mode

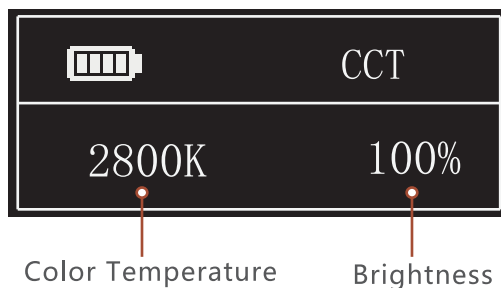

2.1.1 Color temperature adjustment: turn the SET dial to adjust the color temperature from 2800K to 7000K.

2.1.2 Brightness adjustment: turn the DIM dial to adjust the brightness from 0% to 100%.

2.2 Special Effects Mode

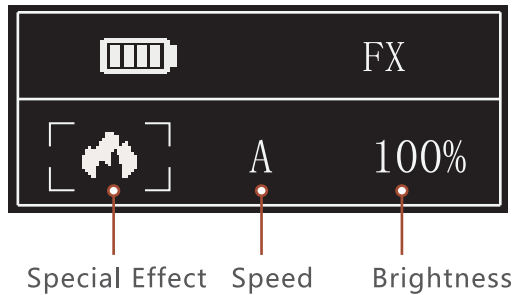

2.2.1 Turn the SET dial to select a special effect. Hit the DIM dial to adjust the speed (A, B, C). Turn the DIM dial to adjust the brightness.

2.2.2 Brightness adjustment: turn the DIM dial to adjust the brightness from 0% to 100%.

2.2.3 There are 12 situational special effects for your choice:

No.	Display	Situation	DisplayA	DisplayB	DisplayC
1		Lightning	Discontinuous	Frequent	Sustainable
2		Flash	Flash	Press Conference	Paparazzi
3		Broken Bulb	Discontinuous	Frequent	Sustainable
4		TV	Slow	Medium	Quick
5		Candle	Discontinuous	Frequent	Sustainable
6		Fire	Firewood	Campfire	Fire Hazard
7		Firework	Brief	Continuous	Show
8		Blast	Discontinuous	Frequent	Sustainable
9		RGB Cycle	Slow	Medium	Quick
10		Impulse	Slow	Medium	Quick
11		Welding	Discontinuous	Frequent	Sustainable
12	SOS	SOS	Slow	Medium	Quick

3. APP Control

3.1 Press and hold the SET dial to turn on Bluetooth. (Press and hold the SET dial again to turn off Bluetooth.)

3.2 Scan the QR code to download the "SIRUI Light" App.

3.3 Turn on Bluetooth, enter the "SIRUI Light" App. Select "E30B LED Light" from the device list.



Scan the QR code to download the App.

For detailed steps, please refer to the APP instruction manual.

4. Installation

4.1 Mount the LED light on a stand via the bottom/lateral 1/4" screw hole.

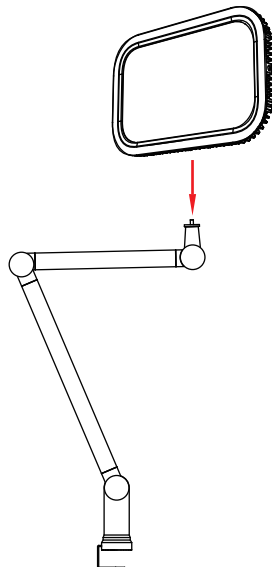
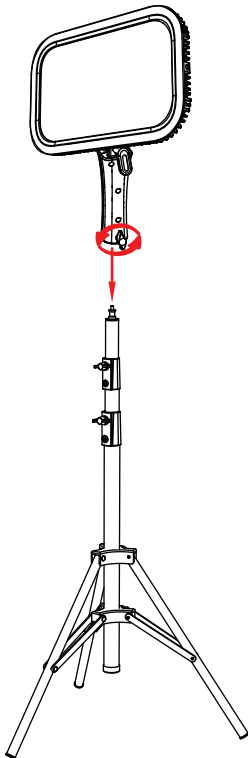

Specifications

Model	E30B
Size	269*169*36mm
Weight	about 880g
Power	about 30W
Color Temperature Range	2800K~7000K
Special Effect	12
100% Illuminance (LUX)	800 lux at 1m
TLCI	98 on average
CRI	96 on average
Working Temperature	-10°C-45°C
Control Method	APP Control
Wireless Bluetooth Control Distance	15m

* Product design and specifications are subject to change without notice.

Warning

1. Always keep this product dry. Do not put it in high-temperature or in damp conditions.
2. Do not touch the product with wet hands. As this product doesn't have waterproof capability, please take measures of waterproof in rainy or damp environment.
3. Use of unauthorized power adapter may cause damage to the product and void the warranty.

Maintenance

1. If there is something wrong with the light when it is working, please turn it off first.
2. It is normal that the light gets a bit hot when it is working.
3. Maintenance must be performed by the authorized maintenance department which can provide original accessories.
4. This product, except for consumables, supports a one-year warranty.
5. Unauthorized service will void the warranty.
6. If the product had failures or was wetted, do not use it until it is repaired by professionals.
7. Changes made to the specifications or designs may not be reflected in this manual.